



www.bandsaw.com.tw



鎂佳機械工業股份有限公司  
MEGA MACHINE CO.,LTD.

台灣 · 411014 台中市太平區工業路180號  
No.180, Industrial Road, Tai-ping District, Taichung City, 411014, Taiwan R. O. C.  
www.bandsaw.com.tw  
Tel: +886-4-22712877 (Rep.) Fax: +886-4-22715016  
E-Mail: sales@bandsaw.com.tw

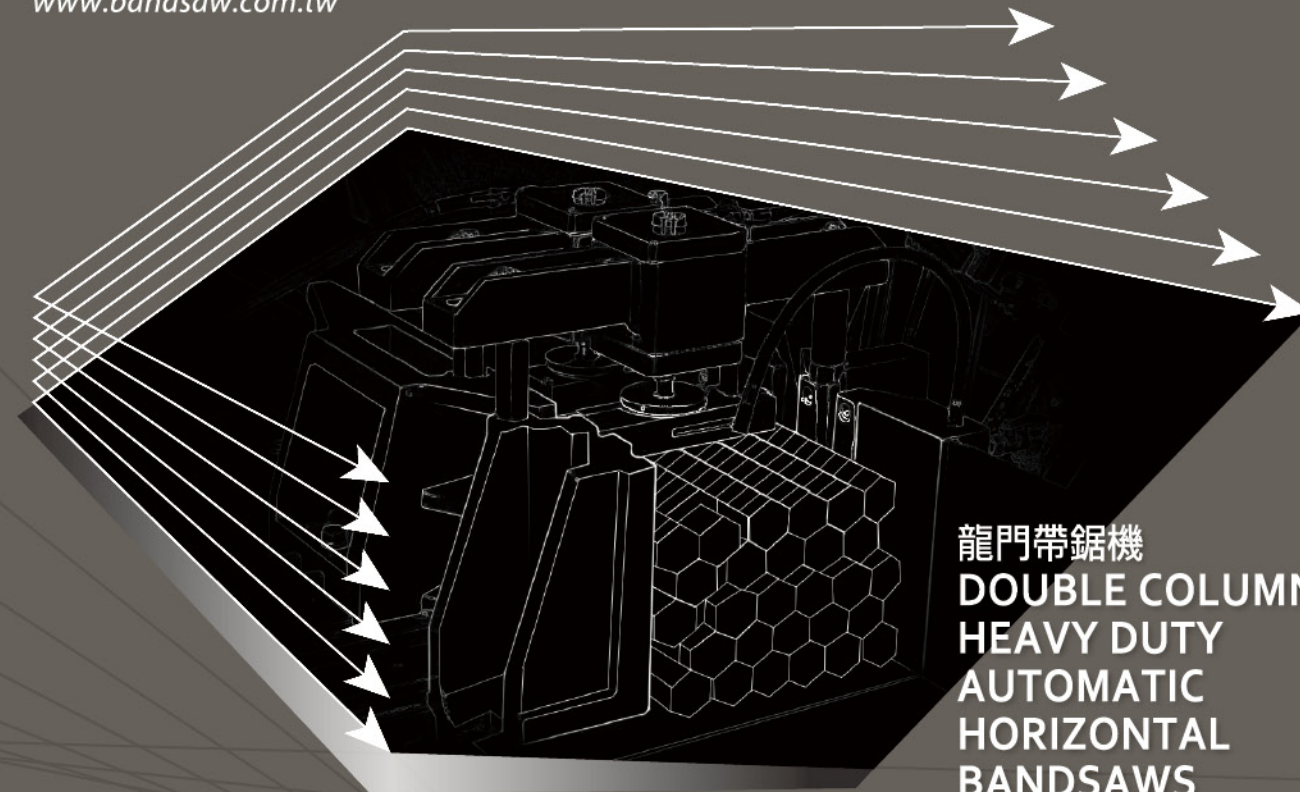

龍門帶鋸機  
DOUBLE COLUMN  
HEAVY DUTY  
AUTOMATIC  
HORIZONTAL  
BANDSAWS

- H-S (伺服進刀 Servo Feedrate)
- H-GA (數值控制 Numeric Control)
- H-A (全自動 Full-Auto)
- H (半自動 Semi-Auto)



Official Website

2024.05  
886-4-2296-5969

Keep Improving & Quality Oriented - Skillful engineering and imaginative design give every MEGA Band Saw Machine exceptional cutting capacity.  
不斷創新與精進 & 嚴格執行品質要求 - 以操作者為出發點的設計, 並追求完美的品質

<b>伺服進刀龍門式帶鋸機</b>	
<b>AUTOMATIC SERVO FEEDRATE DOUBLE COLUMN HORIZONTAL BANDSAW</b>	<b>P3</b>
H-360S/H-400S	P5
H-500S/H-600S	P7
<b>全自動油壓龍門式帶鋸機</b>	
<b>DOUBLE COLUMN HEAVY DUTY AUTOMATIC HORIZONTAL BANDSAW</b>	<b>P9</b>
H-360GA	P13
H-330A/GA	P15
H-400A/GA	P17
H-460A/GA	P19
H-550A/GA	P21
H-600A/GA	P23
H-700A/GA	P25
<b>半自動油壓龍門式帶鋸機</b>	
<b>DOUBLE COLUMN HEAVY DUTY SEMI-AUTOMATIC HORIZONTAL BANDSAWS</b>	<b>P27</b>
H-330	P29
H-400	P29
H-460	P29
H-550	P31
H-600	P31
H-700	P31
<b>機台外觀尺寸 MACHINE DIMENSIONS</b>	<b>P33</b>

**安全設計 – 每一鎂佳機械的帶鋸機皆有以下特點**

**SAFETY DESIGN- Every MEGA Band Saw is factory equipped with**

1. 安全及熱過載開關 Safety and thermal overload switches.
2. 鋸帶及鋸輪安全保護蓋 Well guarded blades and wheel covers.
3. 切削完畢鋸帶自動停止 Saw Blade shuts off automatically when cutting is completed.
4. 低電壓及零電壓控制 Low voltage & zero voltage controls.
5. 鋸帶斷帶偵測 (半自動為選配) A blade breakage sensor/motion detector provides automatic shut-off. (Optional for manual/semi-auto models)



SINCE 1980



ISO9001



TÜV Rheinland Approved

**不斷創新與精進**

今天做得要比昨天做得更好，明天做得要比今天做得還要好，是我們不斷創新，研究發展的精神所在。因為我們深知沒有成長就是退步，沒有創新就是落伍。鎂佳所以兢兢業業，奮發努力，為的是要提供經濟、完美的產品，貢獻業界來降低生產成本，減少胚料損失，提高生產能量，增進原胚料精度，提升自動化程度，促進技術升級，減少能源浪費。

**嚴格執行品質要求**

我們把機器當作是藝術品來處理，每個過程小心翼翼，要求盡善盡美，不容許有任何瑕疵。因為我們知道，為客戶提供完善快速的售後服務，不厭其煩的服務態度並不能使客戶完全滿足，唯有完美的品質，近乎免於服務的機器，才是我們追求的最大目標。

**以操作者為出發點的設計**

客戶的要求，操作者的願望，是本公司一系列帶鋸機設計的參考藍本，以機器來配合人們的操作，而不是以人來配合機器，正是我們全力追求的目標，因此，鎂佳的鋸床，結構剛強，操作容易，安全性高，鋸切能力強勁快速，精密度高，機件、鋸片持久耐用生產能量大，人工最省。

**精良產品永續經營**

鎂佳機械工業股份有限公司，創立於西元 1980 年，成立以全自動油壓帶鋸機、NC 全自動圓鋸機、精密油壓滾牙機、CNC 螺絲磨床之研發、製造、組裝及銷售服務的專業廠商。

隨研發的改進，本公司保有設計變更產品規格的權力與解釋權，確定規格、尺寸、產品資訊以實品為準，若有變更恕不另行通知。 Specifications are subject to change for improvement and modification without prior notice.

**KEEP IMPROVING**

MEGA's R&D has over thirty-year experiences thus forms a strong team. It can provide total solution in screw and gear rolling, metal and nonferrous cutting, worm and thread grinding.

**QUALITY ORIENTED**

MEGA quality policy: "High performance and best quality can catch customers' heart, turning quality into company's "Super Salesman".

**CUSTOMIZED FOR YOU**

MEGA could provide total solution to meet your production requirement.

**PERPETUAL MANAGEMENT**

Since 1980, MEGA machine Co., Ltd has been specializing in designing, producing and assembling, serving customers with bandsaw machine, NC circular saw machine, thread rolling machine and CNC thread grinding machine.



# H-S 伺服進刀龍門式帶鋸機

## AUTOMATIC SERVO FEEDRATE DOUBLE COLUMN HORIZONTAL BANDSAW

全新一代的設計，搭配使用碳化鎢鋸帶，適合切削各種鋼材材質。切削時間更短，鋸帶壽命更長。

The newly designed structure, complied with carbide blade, is suitable for all kinds of metal. It's more efficient and it prolongs the blade service life.



For H-400S For H-600S

### 伺服進刀系統

#### SERVO FEED SYSTEM

伺服馬達搭配滾珠螺桿，無論是高速升降或是切削進刀皆有極佳的表現。The saw frame up and down is controlled by a servo motor with ball screw and rigid linear guides to ensure high speed and high accuracy cutting performance.

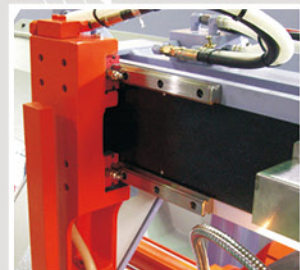

### 游移式導鋸臂 AUTO-POSITIONING GUIDE ARM

自動隨著材料外徑移至適當位置，增加鋸切時的穩定性。The blade guide arm will be moved automatically to the right position according to the size of material.



### 減速機

#### RIGID ,WIDE SPEED RANGE GEAR BOX REDUCER

最新研發的減速機切削速度範圍加大，可切更多種不同材質，高速運轉時也能保持低噪音。This newly developed gear box provides wide speed range (20-120M/min) for cutting most many different materials with much less noise.

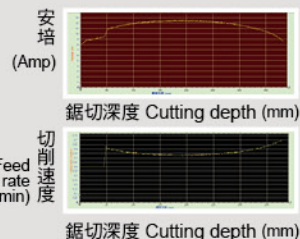
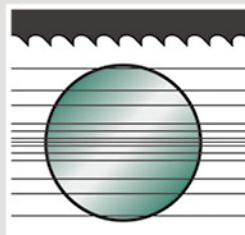

### 進刀變化切斷面 SERVO FEEDRATE CONTROL

本機配有伺服馬達壓力回饋系統，自動偵測切斷面積變化微調進刀速率，大幅延長鋸帶壽命。The cutting feed rate is controlled by a close feedback servo system for auto adjusting optimizing cutting. With this feature using carbide blade can reach 4 times faster cutting performance than traditional HSS blade cutting and much longer blade service life.



For H-360S/H-400S/H-500S

### 簡易人機控制面板

#### EASY OPERATING TOUCH SCREEN CONTROL SYSTEM

搭配 5.7 吋人機介面，操作輕鬆簡易。By using a 5.7 inches touch screen control makes operation easier (human technology interface).

For H-600S

## 機台外觀尺寸 MACHINE DIMENSIONS

### H-360S/H-400S/H-500S

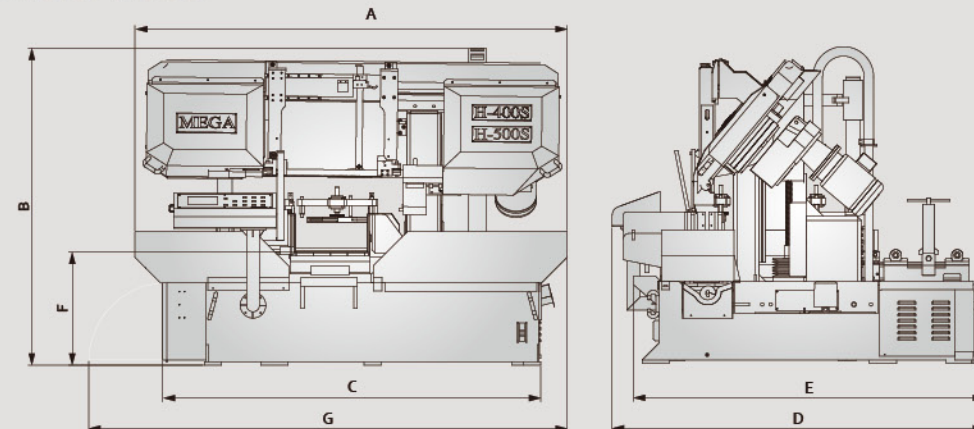

### H-600S

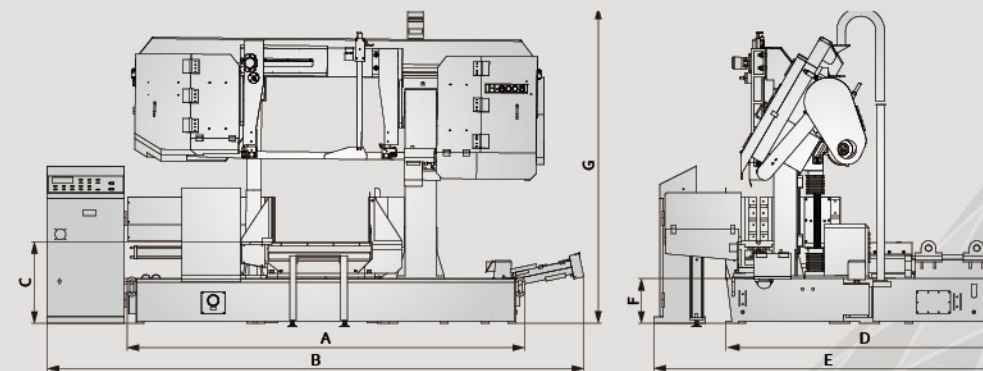

此為示意機器圖片，非實際機器外觀

機型 / 規格 MODEL / SPEC.	單位 UNIT	A	B	C	D	E	F	G
H-360S	mm	2477	2405	2155	2090	2012	766	2764
	in	97.5	80.5	84.8	82.3	79.2	30.1	108.8
H-400S	mm	2550	1900	2250	2180	2055	660	2802
	in	100.4	74.8	88.6	85.8	80.9	26	110.3
H-500S	mm	3185	2244	2951	1940	2235	816	3644
	in	125.4	88.3	116.1	76.4	88	32.1	143.5
H-600S	mm	3036	4100	622	2414	2663	2118	342
	in	119.5	161.4	24.5	95	104.8	83.4	13.5



# H-360S/H-400S

## 伺服進刀龍門式帶鋸機 AUTOMATIC SERVO FEEDRATE DOUBLE COLUMN HORIZONTAL BANDSAW



### 標準配備 Standard Equipment

工具箱 Tools with tool box	1 只 set
2M(7 ft.)長滾輪台 Long roller table with vertical roller guides	1 台 set
清屑鋼刷輪 Band-cleaning wire brush	1 件 pc
鋸帶 Bandsaw blade	1 條 pc
油壓張力 Hydraulic blade tension	1 組 set
自動清屑裝置 Automatic chip conveyor	1 組 set
操作手冊與零件清單 Instruction manual and parts list	1 本 copy

### 選擇配備 Optional Equipment

1. 夾鉗壓力可調 Variable vise pressure system.

### 規格表 Specifications

規格 / 機型 SPEC. / MODEL	H-360S	
鋸切能力 Cutting Capacity	mm	● 400 ■ 400W X 400H
	in	● 15.75 ■ 15.75W X 15.75H
整把切削 Bundle Cutting	mm	最小 Min 170W X 109H / 最大 Max 310W X 200H
	in	最小 Min 6.7W X 4.3H / 最大 Max 12.2W X 7.9H
鋸帶尺寸 Blade Size	mm	41w X 1.3t X 5095L
	in	1.6w X 0.05t X 200.5L
鋸帶速度 Blade Speed	M/min	無段變速 Variable Speed 10-160
	F/min	無段變速 Variable Speed 33-528
馬達 Motor Output	HP	進刀伺服馬達 Servo Feedrate 2, 送料伺服馬達 Bar Feed Servo 2 鋸帶 Blade 15, 油壓 Hyd. 2, 冷卻 Coolant 1/4
	KW	進刀伺服馬達 Servo Feedrate 1.5, 送料伺服馬達 Bar Feed Servo 1.5 鋸帶 Blade 11, 油壓 Hyd. 1.5, 冷卻 Coolant 0.19
封箱尺寸 (L X W X H)	mm	2640 X 2160 X 2280
Shipping Size	ft	103.9 X 85 X 89.8
淨重 / 毛重	kg	2850 / 3075
N.W. / G.W.	lb	6270 / 6765

※ 3 Servo Motors For Blade Speed, Bar Feed, And Feedrate.

### 規格表 Specifications

規格 / 機型 SPEC. / MODEL	H-400S	
鋸切能力 Cutting Capacity	mm	● 400 ■ 400W X 400H
	in	● 16 ■ 16W X 16H
整把切削 Bundle Cutting	mm	最小 Min 200W X 76H / 最大 Max 320W X 230H
	in	最小 Min 7.9W X 3H / 最大 Max 12.6W X 9H
鋸帶尺寸 Blade Size	mm	41w X 1.3t X 5300L
	in	1.6w X 0.05t X 208.7L
鋸帶速度 Blade Speed	M/min	無段變速 Variable Speed 20-120
	F/min	無段變速 Variable Speed 66-398
馬達 Motor Output	HP	進刀伺服馬達 Servo Feedrate 2, 鋸帶 Blade 7.5, 油壓 Hyd. 2, 冷卻 Coolant 1/4
	KW	進刀伺服馬達 Servo Feedrate 1.5, 鋸帶 Blade 5.6, 油壓 Hyd. 1.5, 冷卻 Coolant 0.19
封箱尺寸 (L X W X H)	mm	2700 X 2280 X 1990
Shipping Size	ft	106.3 X 89.8 X 78.3
淨重 / 毛重	kg	2750 / 3000
N.W. / G.W.	lb	6050 / 6600

※ 1 Servo Motor For Feedrate.



# H-500S/H-600S

## 伺服進刀龍門式帶鋸機 AUTOMATIC SERVO FEEDRATE DOUBLE COLUMN HORIZONTAL BANDSAW



### 標準配備 Standard Equipment

工具箱 Tools with tool box	1 只 set
2M(7 ft.)長滾輪台 Long roller table with vertical roller guides	1 台 set
清屑鋼刷輪 Band-cleaning wire brush	1 件 pc
鋸帶 Bandsaw blade	1 條 pc
油壓張力 Hydraulic blade tension	1 組 set
自動清屑裝置 Automatic chip conveyor	1 組 set
操作手冊與零件清單 Instruction manual and parts list	1 本 copy

### 選擇配備 Optional Equipment

1. 夾鉗壓力可調 Variable vise pressure system.

### 規格表 Specifications

規格 / 機型 SPEC. / MODEL	H-500S	
鋸切能力 Cutting Capacity	mm	● 500 ■ 500W X 500H
	in	● 19.68 ■ 19.68W X 19.68H
整把切削 Bundle Cutting	mm	最小 Min 285W X 110H / 最大 Max 500W X 275H
	in	最小 Min 11.2W X 4.3H / 最大 Max 19.7W X 10.8H
鋸帶尺寸 Blade size	mm	67W X 1.6t X 6800L
	in	2.6w X 0.06t X 267.7L
鋸帶速度 Blade Speed	M/min	無段變速 Variable Speed 10-160
	F/min	無段變速 Variable Speed 33-528
馬達 Motor Output	HP	進刀伺服馬達 Servo Feedrate 2, 送料伺服馬達 Bar Feed Servo 2 鋸帶 Blade 20, 油壓 Hyd. 3, 冷卻 Coolant 1 / 4,
	KW	進刀伺服馬達 Servo Feedrate 1.5, 送料伺服馬達 Bar Feed Servo 1.5 鋸帶 Blade 15, 油壓 Hyd. 2.2, 冷卻 Coolant 0.19
封箱尺寸 (L X W X H)	mm	2436 X 2066 X 2444
Shipping Size	ft	95.9 X 81.3 X 96.2
淨重 / 毛重	kg	4020 / 4220
N.W. / G.W.	lb	8844 / 9284

※ 3 Servo Motors For Blade Speed, Bar Feed, And Feedrate.

### 規格表 Specifications

規格 / 機型 SPEC. / MODEL	H-600S	
鋸切能力 Cutting Capacity	mm	● 600 ■ 700W X 600H
	in	● 23.6 ■ 27.5W X 23.6H
鋸帶尺寸 Blade size	mm	67W X 1.6t X 6800L
	in	2.64W X 0.063t X 267.72L
鋸帶速度 Blade Speed	M/min	無段變速 Variable Speed 15-90
	F/min	無段變速 Variable Speed 49-297
馬達 Motor Output	HP	進刀伺服馬達 Servo Feedrate 5, 鋸帶 Blade 20, 油壓 Hyd. 3, 冷卻 Coolant 1 / 4,
	KW	進刀伺服馬達 Servo Feedrate 3.5, 鋸帶 Blade 15, 油壓 Hyd. 2.2, 冷卻 Coolant 0.19
封箱尺寸 (L X W X H)	mm	3670 X 2280 X 2140
Shipping Size	ft	12 X 7.4 X 7
淨重 / 毛重	kg	6100 / 6900
N.W. / G.W.	lb	13420 / 15180

※ 1 Servo Motor For Feedrate.



# H-A 全自動油壓龍門式帶鋸機

## DOUBLE COLUMN HEAVY DUTY AUTOMATIC HORIZONTAL BANDSAW

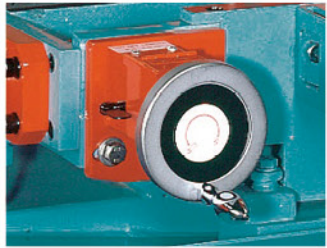

### 精確的鋸切長度設定裝置

在操作者易於操作的位置，本機裝設了一個方便的、數位顯示的鋸切長度切預設裝置，使能夠很精確的、快速的設定所希望鋸切的長度。它的設定單位是 0.1mm，而且能夠在鋸切途中改變下次要鋸切的尺寸，不需停機。

### PRECISE CUT OFF LENGTH SETTING

A convenient digital readout control located at the operator's station provides easy selection of precise bar length requirement. The digital readout is calibrated in 0.10 mm or 0.01 IN increments and can be repositioned without interrupting the cutting cycle.

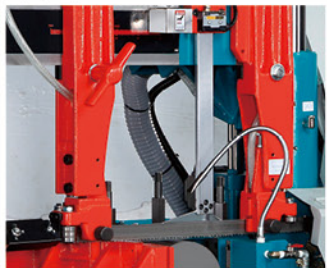

### 鋸帶自動抬高與快速接近設計

在自動鋸切循環中，機台能自動昇高至離材料適當的高度，操作者不用再費心注意。且在機台下降鋸切行程中，此一裝置能夠自動控制機台快速接近工作物，使剛好要在鋸片接觸材料之前，轉換為正常鋸切的下降速度，這一點在自動鋸切循環中，可省去相當多的空車時間。

### AUTO HEAD-ELEVATION AND QUICK APPROACH

Raising the blade higher than necessary to clear the work for the next cut wastes time. Head elevation is controlled automatically and no longer requires the operator's attention. A control device that senses the size of the work piece permits the saw head to raise just high enough so the blade clears the work. This reduces index cycling time significantly.

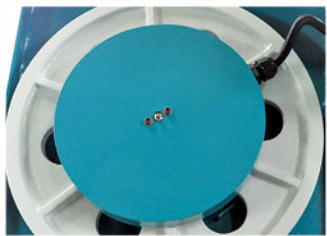

### 鋸片旋轉偵測系統

此一裝置能保護鋸片於過負載切削時免於折損，因為過附載切削，鋸片會卡住於材料中，它能立即偵知停機，而避免繼續下降機台而折斷鋸片。另外，鋸片沒張緊或是意外折斷亦能自動停機。

### IDLE WHEEL MOTION DETECTOR

The device not only can protect the saw blade from damage if the blade overloads/jammed during cutting, but will also shut off the machine if the blade breaks.

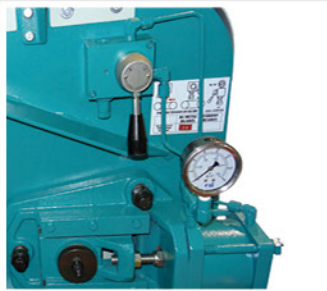

### 油壓鋸帶張力控制

鋸帶切削中張力自動被保持；當關機時，鋸帶張力自動放鬆，能增加鋸帶壽命。

### HYDRAULIC BAND TENSION CONTROL

During operation of the saw the correct tension is automatically maintained. The tension is reduced when the saw is shut-off. This procedure greatly increases blade life.

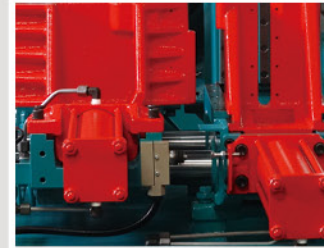

### 快速雙夾鉗，3點夾持系統

設有前後兩組油壓夾鉗來夾緊工作物，前面的主夾鉗更設有雙夾鉗面，總共三點夾持，當鋸切時，鋸片由主夾鉗兩夾鉗面中央，往下鋸切。此一設計在鋸切細長的棒材時，能更穩固的夾緊工作物，以免工作物旋轉。

### QUICK-ACTION HYDRAULIC TWIN-VISE (SPLIT)3-JAW CLAMPING

Materials are firmly clamped on both sides of the saw blade by twin vises. Operating a single switch provides manual or automatic clamping and unclamping materials. This unique design of vise clamps work-piece firmly to avoid material from vibrating or turning while cutting long and thin/small bars/tubes.



### 獨立雙開送料夾鉗

後送料座上的那組夾鉗，可雙向同步動作，即同時打開或同時夾緊，一般鋸床只有一邊可打開和夾緊，固定邊不能動。此一設計最大的好處在於材料表面不平或彎曲時仍可達到精確的送料長度。

### UNIQUE TWO-WAY CARRIAGE VISE JAW

Both vise jaws on the rear work-carriage are actuated simultaneously, opening or closing, instead of the traditional one that is fixed one side moveable on the other. This particular design ensures accurate indexing even warped stock.

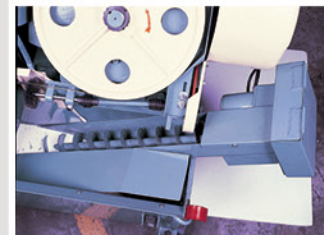

### 自動清屑系統

動力鋼刷輪自動清鋸帶鐵屑；清屑螺桿旋轉能清出鐵屑及過濾切削液。

### AUTOMATIC CHIP CONVEYOR

A power driven brush keeps the saw teeth free of chips. Rotating screw shaft in the coolant drains chips of cutting fluid and propels dry chips out by auger conveyor through a discharge chute.

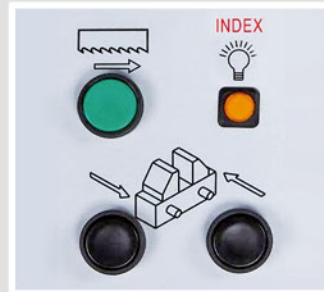

### 送料開關

送料的快速、慢速選擇，使工件可以準確定位在設定長度的位置上。

### INDEX SWITCH

For indexing material smoothly, precisely, and easily to the cutting position.



# H-A 全自動油壓龍門式帶鋸機 DOUBLE COLUMN HEAVY DUTY AUTOMATIC HORIZONTAL BANDSAW

## 選擇配備 Optional Equipment

### 進給控制系統 Cutting feed rate system

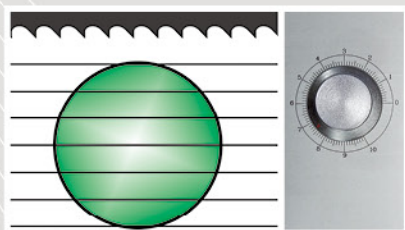

#### 標準 Standard

標準切削進給系統  
Standard cutting feed rate system

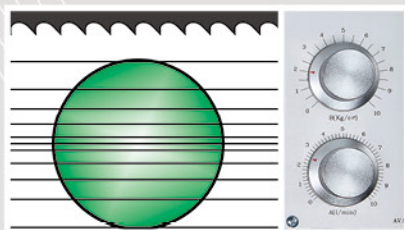

#### 增幅閥 (選配) With Amplifying valve (OPT.)

增幅閥自動調整切削進給率達到最佳切削效果  
Amplifying valve for auto adjusting optimized cutting feedrate system. (Optional available on all models)

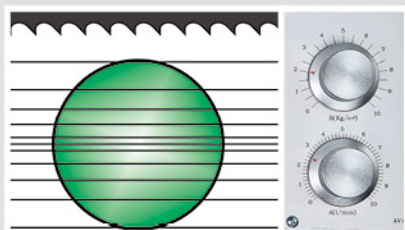

#### 增幅閥 +GA (選配僅適用於全自動機種) Amplifying valve +GA (Optional for automatic models)

GA 系列自動切削長度電腦數值控制 GA Numeric control  
適用於所有自動機種的選配功能，只要將切削長度及數量輸入觸控面板內，機器就能自動將工件鋸切成預設的長度和數量 (有九種或至多 99 種不同的長度 + 數量可設定) For all automatic models, input length and numbers of cuts data into the incorporated touch screen, and the work pieces will be automatically cut into the pre-set lengths and the required numbers (9 or up to 99 different courses available).

如圖顯示不同進給控制系統，請詢問詳細內容以便適合您的需求。

Pictures demonstrated above are different control systems optional available, please ask for full details of a model suited to your particular cutting requirements.

## 鎂佳機械 GA 系列鋸床特色

### 九種切削長度及數量設定

九種切削長度及數量設定僅需透過觸控面板的簡單操作。九組切削資訊會同時顯示在 LED 顯示面板上，目前切削數量則透過燈號閃爍來顯示。

### 自動送料長度補償

觸控螢幕允許設定多組自動切削數值，包含切長料的間隙損失誤差補償，可省去煩人的計算過程。

### 自動錯誤偵測

精密的自我偵測系統會不斷的監測電腦內部狀態。如果有錯誤發生，機台會立即停止運作，錯誤碼會顯示在螢幕上。



數值控制 GA Numeric Control

增幅閥 Amplifying Valve

## Special features for all MEGA GA series bandsaws

### Nine-course setting of length and number of cuts

Cut-off length and the number of cuts can be set in nine courses by simple key-in operation. Total nine courses cutting data are shown on the touch screen at the same time. The current number of cuts is indicated by blinking signal lights.

### Automatic kerf loss compensation

The touch screen permits automatic setting of multiple indexes including kerf loss in long-length cutting. No need for troublesome calculating procedure.

### Automatic errors, signals display

The sophisticated self-diagnosis system constantly monitors the internal state of the computer. Should a failure occur, machine operation will be stopped and the error number of the defective position is indicated.



# H-360GA 全自動油壓龍門式帶鋸機

## DOUBLE COLUMN HEAVY DUTY AUTOMATIC HORIZONTAL BANDSAW

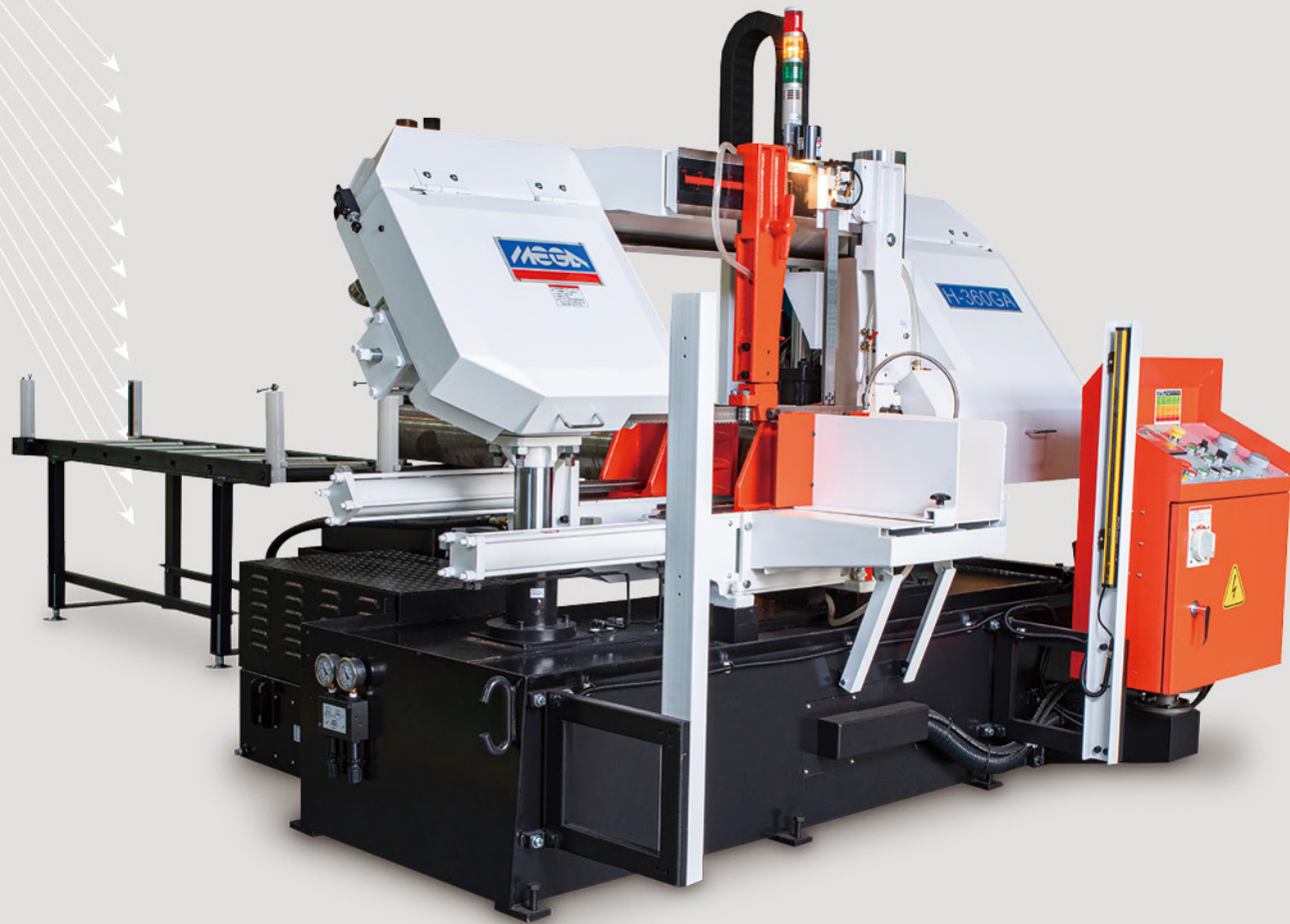

### 規格表 Specifications

規格 / 機型 SPEC. / MODEL	H-360GA	
鋸切能力 Cutting Capacity	mm	● 400 ■ 400W X 400H
	in	● 15.75 ■ 15.75W X 15.75H
整把切削 Bundle Cutting	mm	最小 Min 198W X 130H / 最大 Max 340W X 180H
	in	最小 Min 7.8W X 5.1H / 最大 Max 13.4W X 7.1H
鋸帶尺寸 Blade Size	mm	41W X 1.3t X 4880L
	in	1.6W X 0.05t X 192.1L
鋸帶速度 Blade Speed	M/min	無段變速 Variable Speed 20-120
	F/min	無段變速 Variable Speed 65-390
馬達 Motor Output	HP	鋸帶 Blade 7.5, 油壓 Hyd. 1.5, 冷卻 Coolant 1 / 8
	KW	鋸帶 Blade 5.6, 油壓 Hyd. 2, 冷卻 Coolant 0.1
封箱尺寸 (L X W X H) Shipping Volume	mm	2640 X 2210 X 1910
	ft	8.66 X 7.25 X 6.27
淨重 / 毛重 N.W. / G.W.	kg	2729 / 2959
	lb	6004 / 6510

### 標準配備 Standard Equipment

工具箱 Tools with tool box	1 只 set
2M(7 ft.)長滾輪台 Long roller table with vertical roller guides	1 台 set
清屑鋼刷輪 Band-cleaning wire brush	1 件 pc
鋸帶 Bandsaw blade	1 條 pc
油壓張力 Hydraulic blade tension	1 組 set
自動清屑裝置 Automatic chip conveyor	1 組 set
操作手冊與零件清冊 Instruction manual and parts list	1 本 copy
LED 工作燈 LED work lamp	1 式 set
直截式馬達搭配減速機鋸帶速度 20-120 米 / 分鐘 High efficient gear box reducer for speed 20-120m/min	1 式 set

### 選擇配備 Optional Equipment

- 夾鉗壓力可調 Variable vise pressure system.
- 鋸切速率調整用增幅閥  
Amplifying valve for auto-adjusting cutting feed-rate.
- 防傾斜 Cutting deviation detecting system.
- 深度切削 Cutting depth control.
- 光閘 Safety light curtain in front of machine.
- 三色燈 3-Color LED alarm signal lamp and buzzer.



# H-330A/GA 全自動油壓龍門式帶鋸機

## DOUBLE COLUMN HEAVY DUTY AUTOMATIC HORIZONTAL BANDSAW



### 規格表 Specifications

規格 / 機型 SPEC. / MODEL	H-330A/GA	
鋸切能力 Cutting Capacity	mm	● 330 ■ 350W X 330H
	in	● 13 ■ 13.7W X 13H
整把切削 Bundle Cutting	mm	250W X 175H
	in	9.8W X 6.9H
鋸帶尺寸 Blade Size	mm	34W X 1.1t X 3920L
	in	1.34W X 0.042t X 154.33L
鋸帶速度 Blade Speed	M/min	25,32,42,55,70,80 無段變速 Variable Speed 20-80 (選配 Opt.)
	F/min	82,105,138,180,230,260 無段變速 Variable Speed 65-260 (選配 Opt.)
馬達 Motor Output	HP	鋸帶 Blade 5, 油壓 Hyd. 1, 冷卻 Coolant 1 / 8
	KW	鋸帶 Blade 3.75, 油壓 Hyd. 0.75, 冷卻 Coolant 0.1
封箱尺寸 (L X W X H) Shipping Volume	mm	2200 X 2270 X 1700
	ft	7.22 X 7.45 X 5.58
淨重 / 毛重 N.W. / G.W.	kg	1630 / 1850
	lb	3586 / 4070

### 標準配備 Standard Equipment

工具箱 Tools with tool box	1 只 set
2M(7 ft.)長滾輪台 Long roller table with vertical roller guides	1 台 set
清屑鋼刷輪 Band-cleaning wire brush	1 件 pc
鋸帶 Bandsaw blade	1 條 pc
油壓張力 Hydraulic blade tension	1 組 set
自動清屑裝置 Automatic chip conveyor	1 組 set
操作手冊與零件清單 Instruction manual and parts list	1 本 copy

### 選擇配備 Optional Equipment

1. 鋸速無段變速 Variable blade speed drive.
2. 夾鉗壓力可調 Variable vise pressure system.
3. 鋸切速率調整用增幅閥  
Amplifying valve for auto-adjusting cutting feed-rate.
4. GA 型切削長度電腦數值控制 GA Numeric control.
5. 深度切削 Cutting depth control.



# H-400A/GA 全自動油壓龍門式帶鋸機

## DOUBLE COLUMN HEAVY DUTY AUTOMATIC HORIZONTAL BANDSAW



### 規格表 Specifications

規格 / 機型 SPEC. / MODEL	H-400A/GA	
鋸切能力 Cutting Capacity	mm	● 400 ■ 400W X 400H
	in	● 16 ■ 16W X 16H
整把切削 Bundle Cutting	mm	320W X 230H
	in	12.6W X 9H
鋸帶尺寸 Blade Size	mm	34W X 1.1t X 4570L
	in	1.34W X 0.042t X 179.92L
鋸帶速度 Blade Speed	M/min	25,32,42,55,70,80 無段變速 Variable Speed20-80( 選配 Opt.)
	F/min	82,105,138,180,230,260 無段變速 Variable Speed65-260( 選配 Opt.)
馬達 Motor Output	HP	鋸帶 Blade5, 油壓 Hyd.1, 冷卻 Coolant 1 / 8
	KW	鋸帶 Blade 3.75, 油壓 Hyd 0.75, 冷卻 Coolant 0.1
封箱尺寸 (L X W X H) Shipping Volume	mm	2520 X 2070 X 2000
	ft	8.27 X 6.79 X 6.56
淨重 / 毛重 N.W. / G.W.	kg	2100 / 2320
	lb	4620 / 5104

### 標準配備 Standard Equipment

工具箱 Tools with tool box	1 只 set
2M(7 ft.)長滾輪台 Long roller table with vertical roller guides	1 台 set
清屑鋼刷輪 Band-cleaning wire brush	1 件 pc
鋸帶 Bandsaw blade	1 條 pc
油壓張力 Hydraulic blade tension	1 組 set
自動清屑裝置 Automatic chip conveyor	1 組 set
操作手冊與零件清單 Instruction manual and parts list	1 本 copy

### 選擇配備 Optional Equipment

- 鋸速無段變速 Variable blade speed drive.
- 夾鉗壓力可調 Variable vise pressure system.
- 鋸切速率調整用增幅閥  
Amplifying valve for auto-adjusting cutting feed-rate.
- GA 型切削長度電腦數值控制 GA Numeric control.
- 深度切削 Cutting depth control.



# H-460A/GA 全自動油壓龍門式帶鋸機

## DOUBLE COLUMN HEAVY DUTY AUTOMATIC HORIZONTAL BANDSAW



### 規格表 Specifications

規格 / 機型 SPEC. / MODEL	H-460A/GA	
鋸切能力 Cutting Capacity	mm	● 460 ● 480W X 460H
	in	● 18 ● 18.9W X 18H
整把切削 Bundle Cutting	mm	368W X 210H
	in	14.4W X 8.2H
鋸帶尺寸 Blade Size	mm	41W X 1.3t X 5300L
	in	1.61W X 0.051t X 208.66L
鋸帶速度 Blade Speed	M/min	25,32,42,55,70,80 無段變速 Variable Speed 20-80 (選配 Opt.)
	F/min	82,105,138,180,230,260 無段變速 Variable Speed 65-260 (選配 Opt.)
馬達 Motor Output	HP	鋸帶 Blade 7.5, 油壓 Hyd. 2, 冷卻 Coolant 1 / 8
	KW	鋸帶 Blade 5.6, 油壓 Hyd. 1.5, 冷卻 Coolant 0.1
封箱尺寸 (L X W X H) Shipping Volume	mm	2700 X 2270 X 2050
	ft	8.86 X 7.45 X 6.72
淨重 / 毛重 N.W. / G.W.	kg	3350 / 3600
	lb	7370 / 7920

### 標準配備 Standard Equipment

工具箱 Tools with tool box	1 只 set
2M(7 ft.)長滾輪台 Long roller table with vertical roller guides	1 台 set
清屑鋼刷輪 Band-cleaning wire brush	1 件 pc
鋸帶 Bandsaw blade	1 條 pc
油壓張力 Hydraulic blade tension	1 組 set
自動清屑裝置 Automatic chip conveyor	1 組 set
操作手冊與零件清冊 Instruction manual and parts list	1 本 copy

### 選擇配備 Optional Equipment

1. 鋸速無段變速 Variable blade speed drive.
2. 夾鉗壓力可調 Variable vise pressure system.
3. 鋸切速率調整用增幅閥  
Amplifying valve for auto-adjusting cutting feed-rate.
4. GA 型切削長度電腦數值控制 GA Numeric control.
5. 深度切削 Cutting depth control.



# H-550A/GA 全自動油壓龍門式帶鋸機

## DOUBLE COLUMN HEAVY DUTY AUTOMATIC HORIZONTAL BANDSAW



### 規格表 Specifications

規格 / 機型 SPEC. / MODEL	H-550A/GA	
鋸切能力 Cutting Capacity	mm	● 550 ■ 600W X 550H
	in	● 21.65 ■ 23.65W X 21.65H
整把切削 Bundle Cutting	mm	440W X 250H
	in	17.3W X 9.8H
鋸帶尺寸 Blade Size	mm	41W X 1.3t X 5800L
	in	1.61W X 0.051t X 228.35L
鋸帶速度 Blade Speed	M/min	25,32,42,55,70,80 無段變速 Variable Speed 20-80 (選配 Opt.)
	F/min	82,105,138,180,230,260 無段變速 Variable Speed 65-260 (選配 Opt.)
馬達 Motor Output	HP	鋸帶 Blade 7.5, 油壓 Hyd. 2, 冷卻 Coolant 1 / 8
	KW	鋸帶 Blade 5.6, 油壓 Hyd. 1.5, 冷卻 Coolant 0.1
封箱尺寸 (L X W X H) Shipping Volume	mm	3160 X 2270 X 2260
	ft	10.37 X 7.45 X 7.41
淨重 / 毛重 N.W. / G.W.	kg	3600 / 3800
	lb	7920 / 8360

### 標準配備 Standard Equipment

工具箱 Tools with tool box	1 只 set
2M(7 ft.)長滾輪台 Long roller table with vertical roller guides	1 台 set
清屑鋼刷輪 Band-cleaning wire brush	2 件 pcs
鋸帶 Bandsaw blade	1 條 pc
油壓張力 Hydraulic blade tension	1 組 set
自動清屑裝置 Automatic chip conveyor	1 組 set
操作手冊與零件清單 Instruction manual and parts list	1 本 copy

### 選擇配備 Optional Equipment

1. 鋸速無段變速 Variable blade speed drive.
2. 夾鉗壓力可調 Variable vise pressure system.
3. 鋸切速率調整用增幅閥  
Amplifying valve for auto-adjusting cutting feed-rate.
4. GA 型切削長度電腦數值控制 GA Numeric control.
5. 深度切削 Cutting depth control.
6. 整把切削 Bundle cutting.



# H-600A/GA 全自動油壓龍門式帶鋸機

## DOUBLE COLUMN HEAVY DUTY AUTOMATIC HORIZONTAL BANDSAW



### 規格表 Specifications

規格 / 機型 SPEC. / MODEL	H-600A/GA	
鋸切能力 Cutting Capacity	mm	● 600 ■ 700W X 600H
	in	● 23.6 ■ 27.5W X 23.6H
鋸帶尺寸 Blade Size	mm	54W X 1.6t X 6800L
	in	2.13W X 0.063t X 267.72L
鋸帶速度 Blade Speed	M/min	無段變速 Variable Speed 15-65
	F/min	無段變速 Variable Speed 49-210
馬達 Motor Output	HP	鋸帶 Blade 10, 油壓 Hyd. 3, 冷卻 Coolant 1 / 4
	KW	鋸帶 Blade 7.5, 油壓 Hyd. 2.2, 冷卻 Coolant 0.19
封箱尺寸 (L X W X H) Shipping Volume	mm	3670 X 2280 X 2140
	ft	12.04 X 7.48 X 7.02
淨重 / 毛重 N.W. / G.W.	kg	6100 / 6900
	lb	13420 / 15180

### 標準配備 Standard Equipment

工具箱 Tools with tool box	1 只 set
2M(7 ft.)長滾輪台 Long roller table with vertical roller guides	1 台 set
清屑鋼刷輪 Band-cleaning wire brush	2 件 pcs
鋸帶 Bandsaw blade	1 條 pc
油壓張力 Hydraulic blade tension	1 組 set
自動清屑裝置 Automatic chip conveyor	1 組 set
操作手冊與零件清冊 Instruction manual and parts list	1 本 copy

### 選擇配備 Optional Equipment

1. 鋸速無段變速 Variable blade speed drive.
2. 夾鉗壓力可調 Variable vise pressure system.
3. 鋸切速率調整用增幅閥  
Amplifying valve for auto-adjusting cutting feed-rate.
4. GA 型切削長度電腦數值控制 GA Numeric control.
5. 深度切削 Cutting depth control.
6. 防傾斜裝置 Cutting deviation detecting system.



# H-700A/GA 全自動油壓龍門式帶鋸機

## DOUBLE COLUMN HEAVY DUTY AUTOMATIC HORIZONTAL BANDSAW



### 規格表 Specifications

規格 / 機型 SPEC. / MODEL	H-700A/GA	
鋸切能力 Cutting Capacity	mm	● 720 ■ 800W X 720H
	in	● 28.35 ■ 31.5W X 28.35H
鋸帶尺寸 Blade Size	mm	54W X 1.6t X 8128L
	in	2.13W X 0.063t X 320L
鋸帶速度 Blade Speed	M/min	無段變速 Variable Speed 15-65
	F/min	無段變速 Variable Speed 49-210
馬達 Motor Output	HP	鋸帶 Blade10, 油壓 Hyd. 3, 冷卻 Coolant 1 / 4
	KW	鋸帶 Blade7.5, 油壓 Hyd. 2.2, 冷卻 Coolant 0.19
封箱尺寸 (L X W X H) Shipping Volume	mm	4010 X 2290 X 2560
	ft	13.17 X 7.51 X 8.4
淨重 / 毛重 N.W. / G.W.	kg	5300 / 6000
	lb	11660 / 13200

### 標準配備 Standard Equipment

工具箱 Tools with tool box	1 只 set
2M(7 ft.)長滾輪台 Long roller table with vertical roller guides	1 台 set
清屑鋼刷輪 Band-cleaning wire brush	2 件 pcs
鋸帶 Bandsaw blade	1 條 pc
油壓張力 Hydraulic blade tension	1 組 set
自動清屑裝置 Automatic chip conveyor	1 組 set
操作手冊與零件清冊 Instruction manual and parts list	1 本 copy

### 選擇配備 Optional Equipment

- 鋸速無段變速 Variable blade speed drive.
- 夾鉗壓力可調 Variable vise pressure system.
- 鋸切速率調整用增幅閥  
Amplifying valve for auto-adjusting cutting feed-rate.
- GA 型切削長度電腦數值控制 GA Numeric control.
- 深度切削 Cutting depth control.
- 防傾斜裝置 Cutting deviation detecting system.



# H 半自動油壓龍門式帶鋸機 DOUBLE COLUMN HEAVY DUTY SEMI-AUTOMATIC HORIZONTAL BANDSAWS

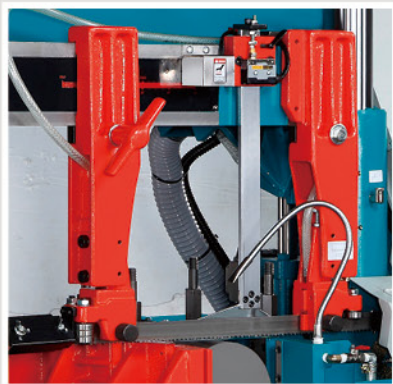

## 快速螺旋式碳化鎢導鋸

本機全部採用碳化鎢導鋸片來導引鋸帶，使鋸帶能具有剛性和直線精度。而碳化鎢的鬆緊則採用螺旋來操作，不但省力，而且快速，操作者要更換新的鋸帶時使用此一設計可說是輕鬆容易。

## QUICK-ADJUSTING CARBIDE SAW-BAND GUIDES

For the replacement of the saw blade or the repositioning of the guide arms, two levers are incorporated in the saw guides to allow these operations to be carried out quickly and efficiently.



## 動力鋼刷輪

動力鋼刷輪由強力冷卻液噴刷，確保鋸刀切削時無鐵屑。

## POWER-DRIVEN SAW-BAND BRUSH

A power-driven saw-band brush, continually flushed by a cutting fluid spout, keeps the blade and saw guides free of chips for smoother cutting. A flush hose is available for washing chips and debris away from the cutting area.

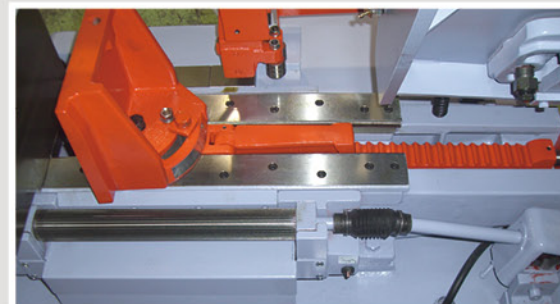

## 浮動滾輪機構

使用搖桿設定夾鉗及浮動滾輪，當夾鉗開啟時滾輪上升，藉著手輪輕鬆地送料前進。

## FLOATING ROLLER FEED MECHANISM

Cylinder lifts stock a little to make feeding smoothly with floating roller.

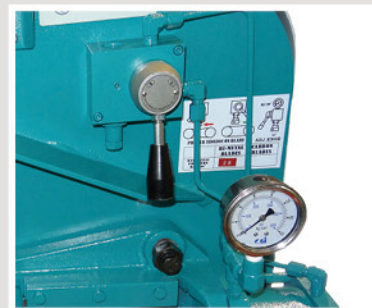

## 壓鋸帶張力控制

鋸帶切削中張力自動被保持；當關機時，鋸帶張力自動放鬆，能增加鋸帶壽命。

## HYDRAULIC BAND TENSION CONTROL

During operation of the saw the correct tension is automatically maintained. The tension is reduced when the saw is shut off. This procedure greatly increases blade life.



## 鋸片旋轉偵測系統 (選配)

此裝置能偵測鋸帶過負載及斷裂，並能自動停機。

## IDLE WHEEL MOTION DETECTOR (Opt.)

The device not only can protect the saw blade from damage if the blade overloads/ jammed during cutting, but will also shut off the machine if the blade breaks.



# H-330/400/460 半自動油壓龍門式帶鋸機

## DOUBLE COLUMN HEAVY DUTY SEMI-AUTOMATIC HORIZONTAL BANDSAWS



### 規格表 Specifications

規格 / 機型 SPEC. / MODEL	H - 330	H - 400	H - 460
鋸切能力 Cutting Capacity	mm ● 330 ■ 350W X 330H ● 400 ■ 400W X 400H ● 460 ■ 480W X 460H		
	in ● 13 ■ 13.7W X 13H ● 16 ■ 16W X 16H 18 ■ 18.9 W X 18H		
鋸帶尺寸 Blade Size	mm 34W X 1.1t X 3920L 34W X 1.1t X 4570L 41W X 1.3t X 5300L		
	in 1.34W X 0.042t X 154.33L 1.34W X 0.042t X 179.92L 1.61W X 0.051t X 208.66L		
鋸帶速度 Blade Speed	M/min 25,32,42,55,70,80, 無段變速 Variable Speed 20-80 (選配 Opt.)		
	F/min 82,105,138,180,230,260 無段變速 Variable Speed 65-260 (選配 Opt.)		
馬達 Motor Output	HP 鋸帶 Blade 5, 油壓 Hyd. 1, 冷卻 Coolant 1/8	鋸帶 Blade 5, 油壓 Hyd. 1, 冷卻 Coolant 1/8	鋸帶 Blade 7.5, 油壓 Hyd. 2, 冷卻 Coolant 1/8
	KW 鋸帶 Blade 3.75, 油壓 Hyd. 0.75, 冷卻 Coolant 0.1	鋸帶 Blade 3.75, 油壓 Hyd. 0.75, 冷卻 Coolant 0.1	鋸帶 Blade 5.6, 油壓 Hyd. 1.5, 冷卻 Coolant 0.1
封箱尺寸 (L X W X H) Shipping Volume	mm 2210 X 1490 X 1700 2420 X 1360 X 1820 2690 X 1780 X 2100		
	ft 7.25 X 4.89 X 5.28 7.94 X 4.46 X 5.97 8.83 X 5.84 X 6.89		
淨重 / 毛重 N.W. / G.W.	kg 1160 / 1460 1640 / 1840 2300 / 2800		
	lb 2252 / 3212 3608 / 4048 5060 / 6160		

### 標準配備 Standard Equipment

工具箱 Tools with tool box	1 只 set
1.5M(5 ft.)長滾輪台 Long roller table with vertical roller guides	1 台 set
清屑鋼刷輪 Band-cleaning wire brush	1 件 pc
鋸帶 Bandsaw blade	1 條 pc
操作手冊 Instruction manual	1 本 copy

### 選擇配備 Optional Equipment

- 額外之送料台、清屑鋼刷輪、鋸帶、工作燈  
Additional spare roller table, wire brush, saw blade, work-area light, etc.
- 鋸速無段變速 Variable blade speed drive.
- 夾鉗壓力可調 Variable vise pressure system.
- 鋸切速率調整用增幅閥 Amplifying valve for auto-adjusting cutting feed-rate.
- 自動清屑系統 Automatic chip conveyor.
- 鋸帶斷裂偵測 Idle wheel motion detector for blade jam/break shut-off.
- 整把切削 Bundle cutting.



# H-550/600/700 半自動油壓龍門式帶鋸機

DOUBLE COLUMN HEAVY DUTY SEMI-AUTOMATIC HORIZONTAL BANDSAWS

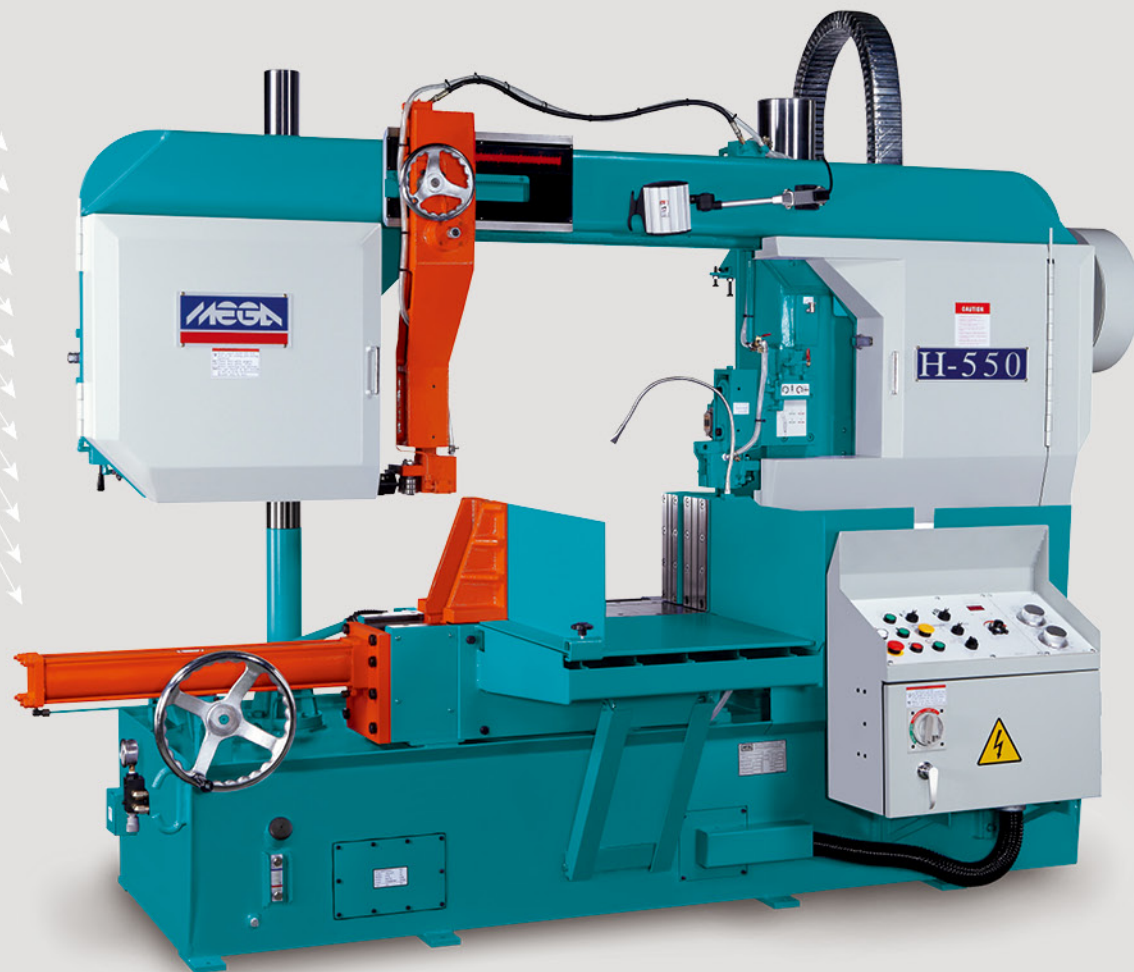

## 規格表 Specifications

規格 / 機型 SPEC. / MODEL		H - 550	H - 600	H - 700
鋸切能力 Cutting Capacity	mm	● 550 ■ 600W X 550H	● 600 ■ 700W X 600H	● 720 ■ 800W X 720H
	in	● 22 ■ 24W X 22H	● 23.6 ■ 27.5W X 23.6H	● 28 ■ 31.5W X 28H
整把切削 (選配) Bundle Cutting (Opt.)	mm	440W X 250H	N/A	N/A
	in	17.3W X 9.8H		
鋸帶尺寸 Blade Size	mm	41W X 1.3t X 5800L	54W X 1.6t X 6800L	54W X 1.6t X 8128L
	in	1.61W X 0.051t X 228.35L	2.13W X 0.063t X 267.72L	2.13W X 0.063t X 320L
鋸帶速度 Blade Speed	M/min	25,32,42,55,70,80, 無段變速 Variable Speed 20-80 (選配 Opt.)	無段變速 Variable Speed 15-65 (選配 Opt.)	
	F/min	82,105,138,180,230,260 無段變速 Variable Speed 65-260 (選配 Opt.)	無段變速 Variable Speed 49-210 (選配 Opt.)	
馬達 Motor Output	HP	鋸帶 Blade 7.5, 油壓 Hyd. 2, 冷卻 Coolant 1/8	鋸帶 Blade 10, 油壓 Hyd. 3, 冷卻 Coolant 1 / 4	
	KW	鋸帶 Blade 5.6, 油壓 Hyd. 1.5, 冷卻 Coolant 0.1	鋸帶 Blade 7.5, 油壓 Hyd. 2.2, 冷卻 Coolant 0.19	
封箱尺寸 (L X W X H) Shipping Volume	mm	3150 X 1570 X 2260	3330 X 2280 X 2260	4010 X 1790 X 2560
	ft	10.33 X 5.15 X 7.41	10.93 X 7.48 X 7.41	13.16 X 5.87 X 8.39
淨重 / 毛重 N.W. / G.W.	kg	2500 / 3000	4300 / 5000	4700 / 5200
	lb	5500 / 6600	9460 / 11000	10340 / 11440

## 標準配備 Standard Equipment

工具箱 Tools with tool box	1 只 set
1.5M(5 ft.)長滾輪台 Long roller table with vertical roller guides	1 台 set
清屑鋼刷輪 Band-cleaning wire brush	2 件 pcs
鋸帶 Bandsaw blade	1 條 pc
操作手冊與零件清單 Instruction manual and parts list	1 本 copy

## 選擇配備 Optional Equipment

1. 自動清屑系統 Automatic chip conveyor.
2. 鋸速無段變速 Variable blade speed drive.
3. 夾鉗壓力可調 Variable vise pressure system.
4. 鋸切速率調整用增幅閥 Amplifying valve for auto-adjusting cutting feed-rate.
5. 防傾斜裝置 Cutting deviation detecting system.(只適用於 H600/H700 Only for H600/H700)
6. 額外之送料台、清屑鋼刷輪、鋸帶、工作燈  
Additional spare roller table, wire brush, saw blade, work-area light, etc.
7. 整把切削 (僅適用於 H550) Bundle cutting (Only for H550)

## 全自動油壓龍門式帶鋸機

DOUBLE COLUMN HEAVY DUTY AUTOMATIC HORIZONTAL BANDSAW

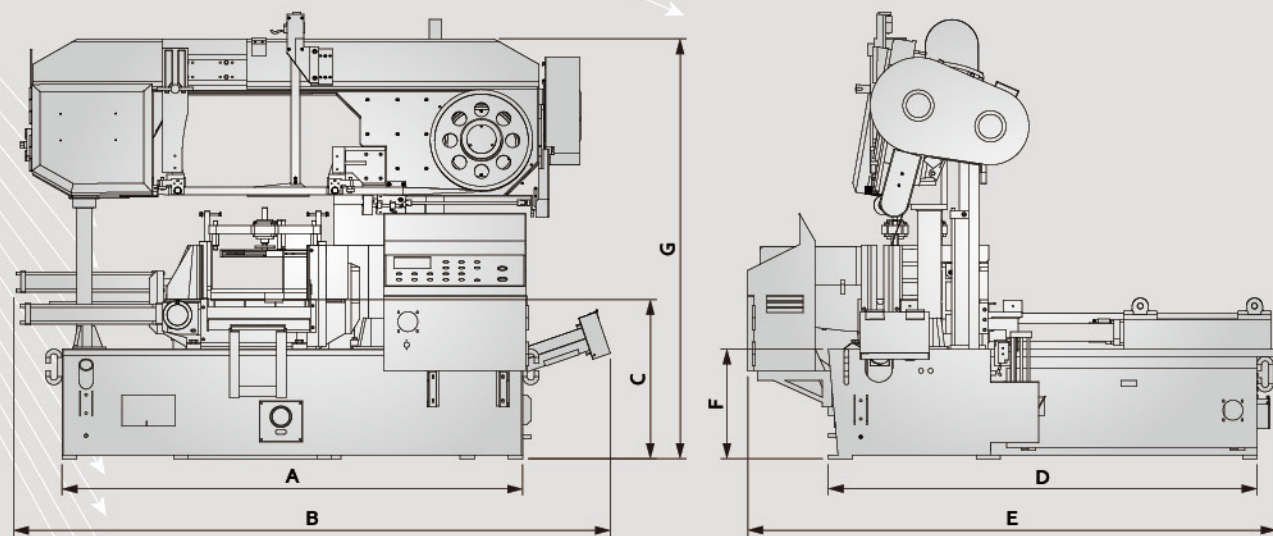

機型 / 規格 MODEL / SPEC.	單位 UNIT	A	B	C	D	E	F	G
H-360GA	mm	2320	2744	718	1925	2330	472	1890
	inch	91.3	108	28.3	75.8	91.7	18.6	74.4
H-330A/GA	mm	1650	2261	709	1718	2111	524	1730
	inch	65.0	89.0	27.9	67.6	83.1	20.6	68.1
H-400A/GA	mm	1915	2471	662	1782	2197	456	1857
	inch	75.4	97.3	26.1	70.2	86.5	18.0	73.1
H-460A/GA	mm	2320	2796	749	2030	2560	500	2005
	inch	91.3	110.1	29.5	79.9	100.8	19.7	78.9
H-550A/GA	mm	2322	3134	710	2014	2535	460	2186
	inch	91.4	123.4	28.0	79.3	99.8	18.1	86.1
H-600A/GA	mm	2900	3427	622	2050	2580	342	2414
	inch	114.2	134.9	24.5	80.7	101.6	13.5	95.0
H-700A/GA	mm	2900	3866	608	2086	2400	356	2386
	inch	114.2	152.2	23.9	82.1	94.5	14.0	93.9

## 半自動油壓龍門式帶鋸機

DOUBLE COLUMN HEAVY DUTY SEMI-AUTOMATIC HORIZONTAL BANDSAWS

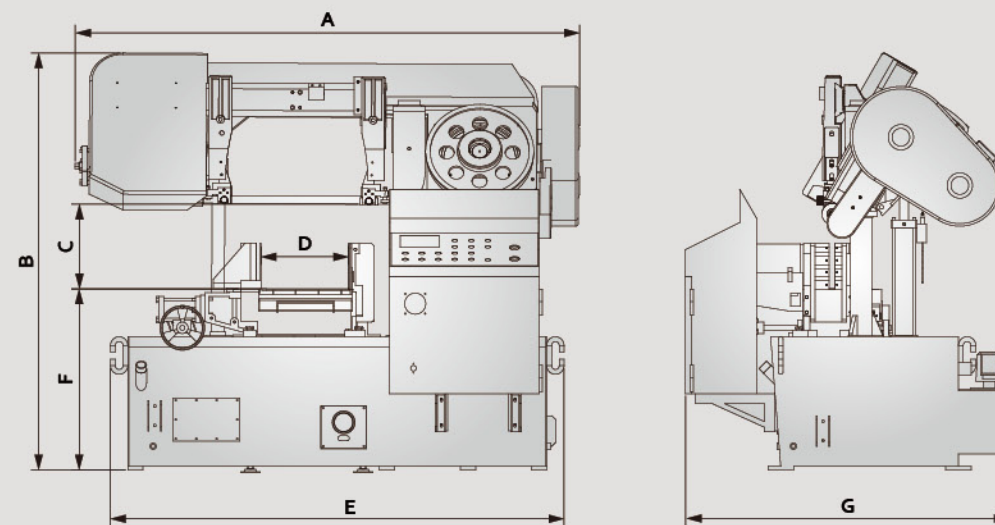

機型 / 規格 MODEL / SPEC.	單位 UNIT	A	B	C	D	E	F	G
H-330	mm	2150	1680	350	345	1650	716	742
	inch	84.6	66.1	13.8	13.6	65.0	28.2	29.2
H-400	mm	2267	1810	420	425	1915	662	650
	inch	89.3	71.3	16.5	16.7	75.4	26.1	25.6
H-460	mm	2720	1905	480	480	2000	749	900
	inch	107.1	75.0	18.9	18.9	78.7	29.5	35.4
H-550	mm	2850	2186	600	640	2322	710	1170
	inch	112.2	86.1	23.6	25.2	91.4	28.0	46.1
H-600	mm	3550	2550	625	650	2900	716	2300
	inch	139.8	100.4	24.6	25.6	114.2	28.2	90.6
H-700	mm	3803	2370	800	720	2900	608	1070
	inch	149.7	93.3	31.5	28.3	114.2	23.9	42.1